

Chapter 6: Project Time Management

*King Fahd University of Petroleum & Minerals
SWE 417: Software Project Management
Semester: 072*

Learning Objectives

- Understand the importance of project schedules
- Define activities as the basis for developing project schedules
- Explain how various tools and techniques help project managers perform activity duration estimating and schedule development
- Understand and use tools and techniques for schedule development (Gantt charts, PERT analysis, critical path analysis, and critical chain scheduling)

Importance of Project Schedules

- Managers often cite delivering projects on time as one of their biggest challenges.
- Schedule issues are the main reason for conflicts on projects, especially during the second half of projects.
- Time has the least amount of flexibility; it passes no matter what happens on a project.

Project Time Management Processes

- **Activity definition:** Identifying the specific activities that the project team members and stakeholders must perform to produce the project deliverables.
- **Activity sequencing:** Identifying and documenting the relationships between project activities.
- **Activity resource estimating:** Estimating how many resources a project team should use to perform project activities.
- **Activity duration estimating:** Estimating the number of work periods that are needed to complete individual activities.
- **Schedule development:** Analyzing activity sequences, activity resource estimates, and activity duration estimates to create the project schedule.
- **Schedule control:** Controlling and managing changes to the project schedule.

Activity Definition

- An **activity** or **task** is an element of work normally found on the WBS that has an expected duration, a cost, and resource requirements.
- Project schedules grow out of the basic documents that initiate a project.
 - The project charter includes start and end dates and budget information.
 - The scope statement and WBS help define what will be done.
- Activity definition involves developing a more detailed WBS and supporting explanations to understand all the work to be done, so you can develop realistic cost and duration estimates.

Activity Lists and Attributes

- An **activity list** is a tabulation of activities to be included on a project schedule. The list should include:
 - The activity name
 - An activity identifier or number
 - A brief description of the activity
- **Activity attributes** provide more information about each activity, such as predecessors, successors, logical relationships, resource requirements, constraints, imposed dates, and assumptions related to the activity.

Milestones

- A **milestone** is a significant event that normally has no duration.
- It often takes several activities and a lot of work to complete a milestone.
- Milestones are useful tools for setting schedule goals and monitoring progress.
- Examples include completion and customer sign-off on key documents and completion of specific products.

Activity Sequencing

- Involves reviewing activities and determining dependencies.
- A **dependency** or **relationship** relates to the sequencing of project activities or tasks.
- You *must* determine dependencies in order to use critical path analysis.

Three Types of Dependencies

- **Mandatory dependencies:** Inherent in the nature of the work being performed on a project; sometimes referred to as hard logic.
- **Discretionary dependencies:** Defined by the project team; sometimes referred to as soft logic and should be used with care because they may limit later scheduling options.
- **External dependencies:** Involve relationships between project and non-project activities.

Network Diagrams

- Network diagrams are the preferred technique for showing activity sequencing.
- A **network diagram** is a schematic display of the logical relationships among, or sequencing of, project activities.
- Two main formats are the arrow and precedence diagramming methods.

Sample Activity-on-Arrow (AOA) Network Diagram for Project X

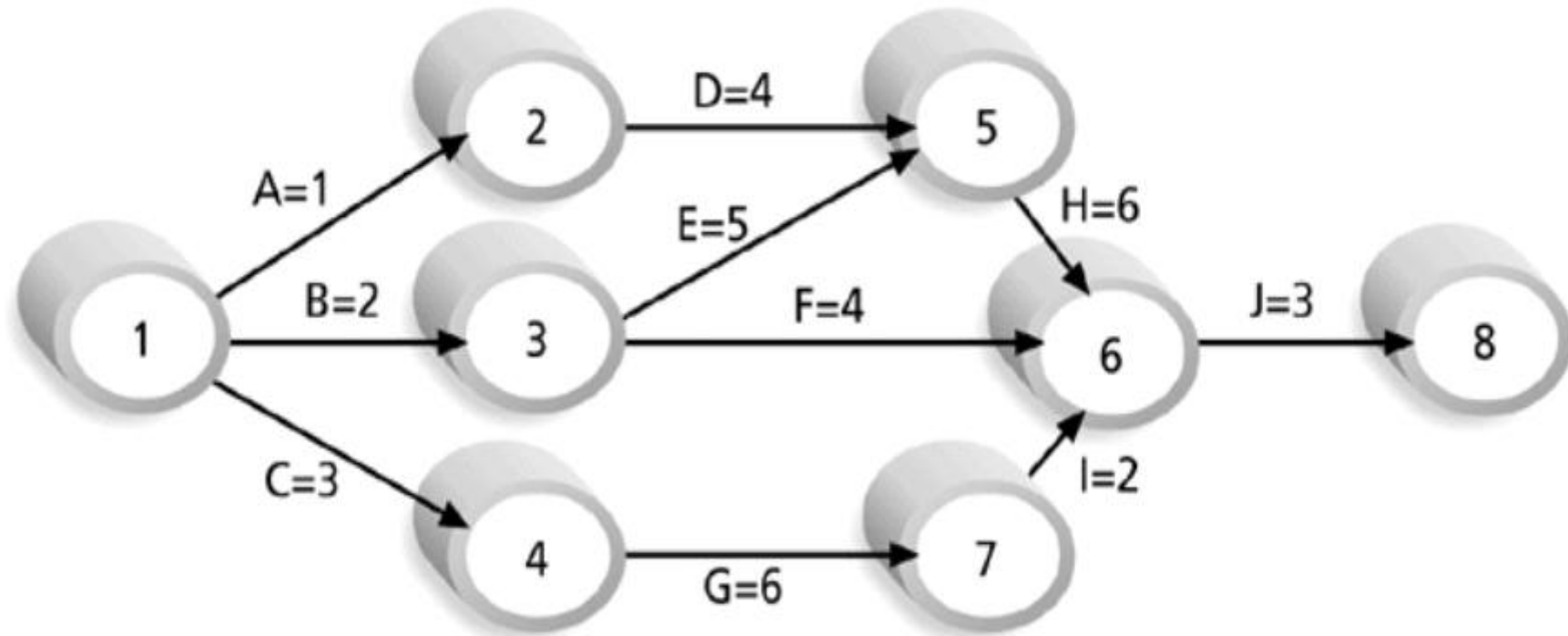

Note: Assume all durations are in days; A=1 means Activity A has a duration of 1 day.

Arrow Diagramming Method (ADM)

- Also called activity-on-arrow (AOA) network diagram.
- Activities are represented by arrows.
- Nodes or circles are the starting and ending points of activities.
- Can only show finish-to-start dependencies.

Process for Creating AOA Diagrams

1. Find all of the activities that start at node 1. Draw their finish nodes and draw arrows between node 1 and those finish nodes. Put the activity letter or name and duration estimate on the associated arrow.
2. Continuing drawing the network diagram, working from left to right. Look for bursts and merges. A **burst** occurs when a single node is followed by two or more activities. A **merge** occurs when two or more nodes precede a single node.
3. Continue drawing the project network diagram until all activities that have dependencies are included in the diagram.
4. As a rule of thumb, all arrowheads should face toward the right, and no arrows should cross in an AOA network diagram.

Precedence Diagramming Method (PDM)

- Activities are represented by boxes.
- Arrows show relationships between activities.
- More popular than ADM method and used by project management software.
- Better at showing different types of dependencies.

Task Dependency Types

Task dependencies

The nature of the dependencies between linked tasks. You link tasks by defining a dependency between their finish and start dates. For example, the "Contact caterers" task must finish before the start of the "Determine menus" task. There are four kinds of task dependencies in Microsoft Project:

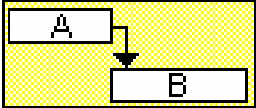
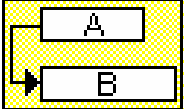
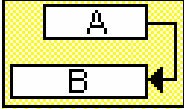
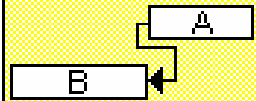
Task dependency	Example	Description
Finish-to-start (FS)		Task (B) cannot start until task (A) finishes.
Start-to-start (SS)		Task (B) cannot start until task (A) starts.
Finish-to-finish (FF)		Task (B) cannot finish until task (A) finishes.
Start-to-finish (SF)		Task (B) cannot finish until task (A) starts.

Sample PDM Network Diagram

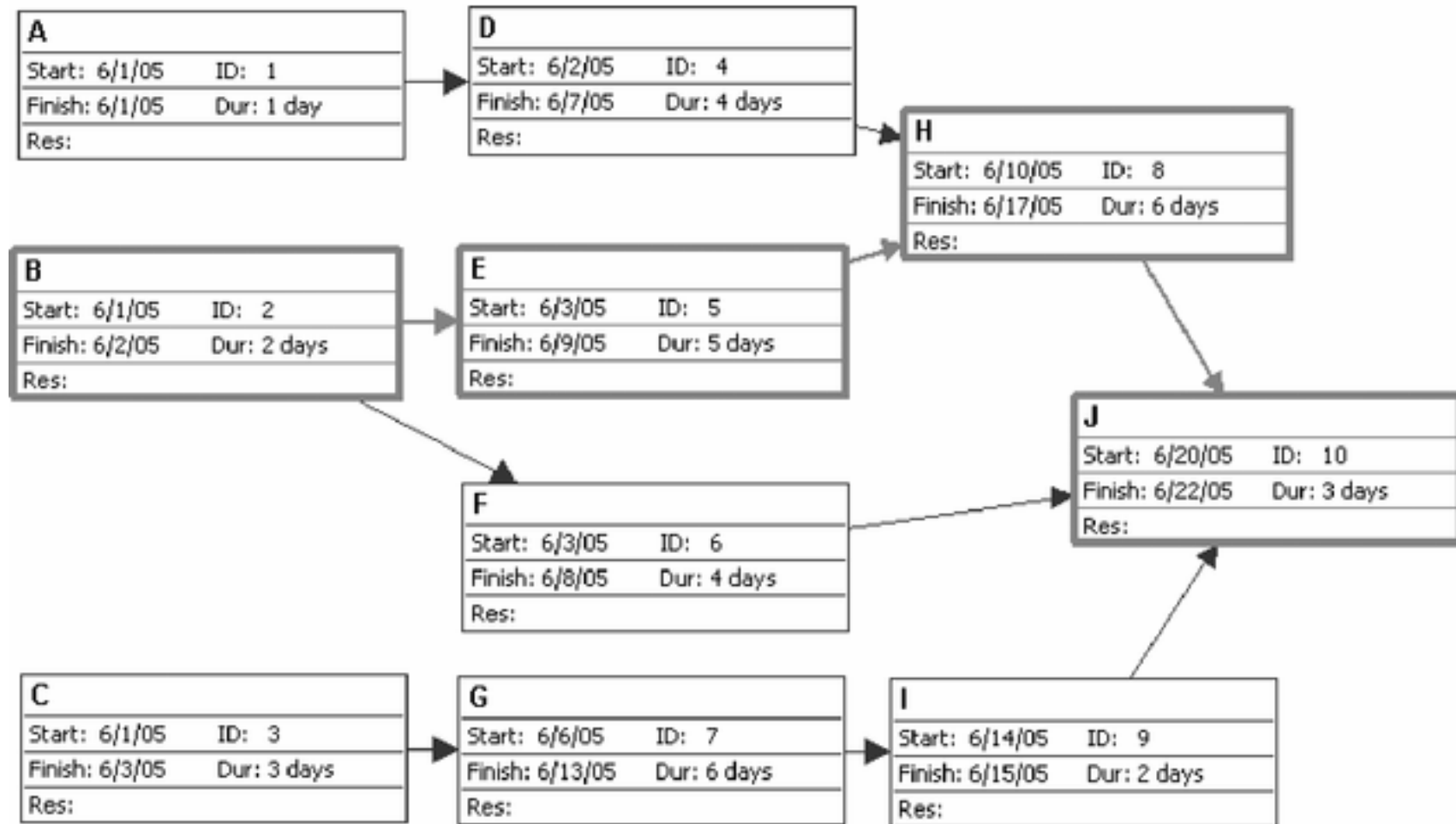

Activity Resource Estimating

- Before estimating activity durations, you must have a good idea of the quantity and type of resources that will be assigned to each activity.
- Consider important issues in estimating resources:
 - How difficult will it be to complete specific activities on this project?
 - What is the organization's history in doing similar activities?
 - Are the required resources available?

Activity Duration Estimating

- **Duration** includes the actual amount of time worked on an activity *plus* the elapsed time.
- **Effort** is the number of workdays or work hours required to complete a task.
- Effort does not normally equal duration.
- People doing the work should help create estimates, and an expert should review them.

Three-Point Estimates

- Instead of providing activity estimates as a discrete number, such as four weeks, it's often helpful to create a **three-point estimate**:
 - An estimate that includes an optimistic, most likely, and pessimistic estimate, such as three weeks for the optimistic, four weeks for the most likely, and five weeks for the pessimistic estimate.

Schedule Development

- Uses results of the other time management processes to determine the start and end dates of the project.
- Ultimate goal is to create a realistic project schedule that provides a basis for monitoring project progress for the time dimension of the project.
- Important tools and techniques include Gantt charts, critical path analysis, critical chain scheduling, and PERT analysis.

Gantt Charts

- **Gantt charts** provide a standard format for displaying project schedule information by listing project activities and their corresponding start and finish dates in a calendar format.
- Symbols include:
 - **Black diamonds:** Milestones
 - **Thick black bars:** Summary tasks
 - **Lighter horizontal bars:** Durations of tasks
 - **Arrows:** Dependencies between tasks

Adding Milestones to Gantt Charts

- Many people like to focus on meeting milestones, especially for large projects.
- Milestones emphasize important events or accomplishments in projects.
- You typically create milestone by entering tasks that have a zero duration, or you can mark any task as a milestone.

SMART Criteria

- Milestones should be:
 - **Specific**
 - **Measurable**
 - **Assignable**
 - **Realistic**
 - **Time-framed**

Sample Tracking Gantt Chart

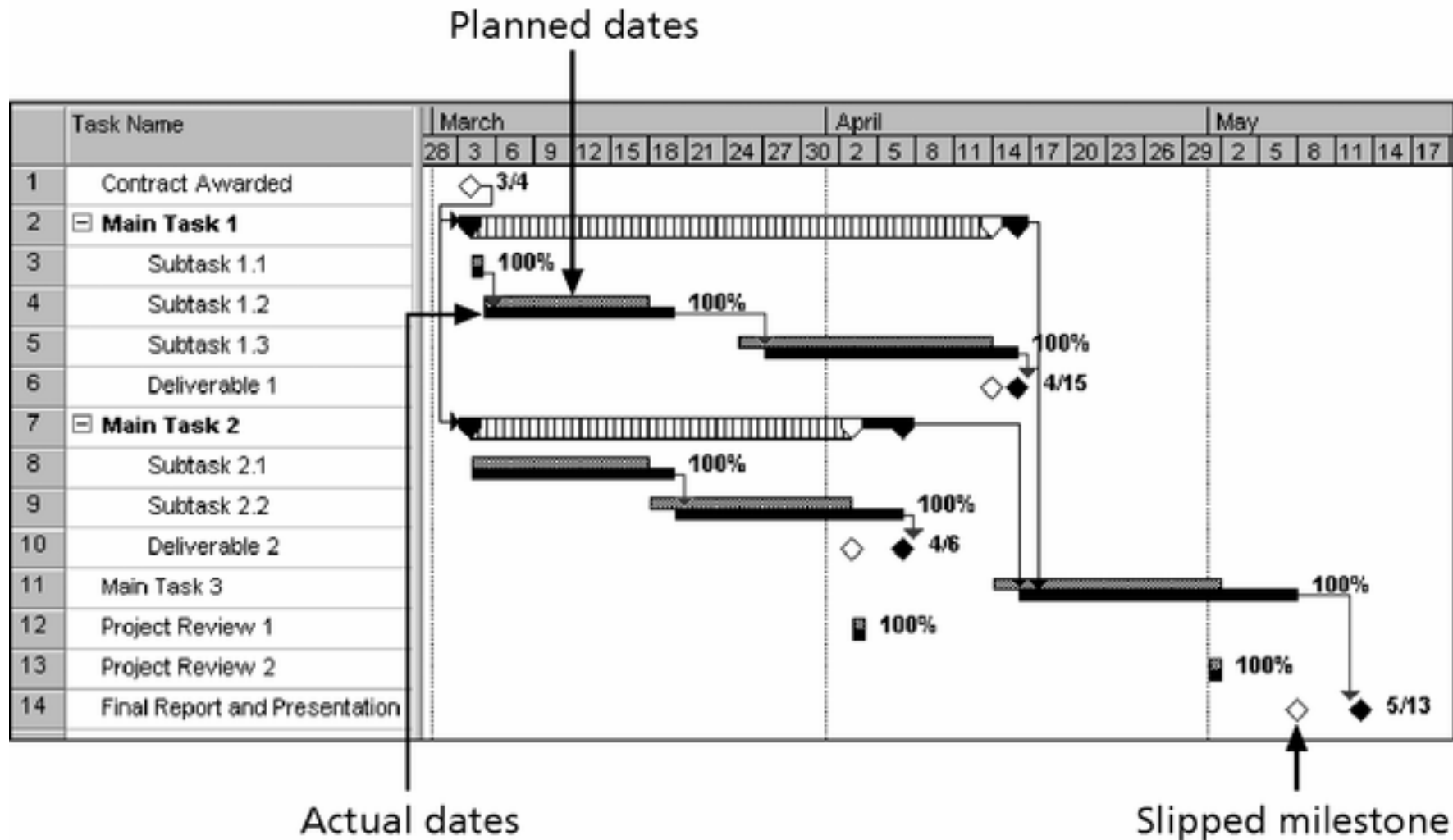

Critical Path Method (CPM)

- **CPM** is a network diagramming technique used to predict total project duration.
- A **critical path** for a project is the series of activities that determines the *earliest time* by which the project can be completed.
- The critical path is the *longest path* through the network diagram and has the least amount of slack or float.
- **Slack** or **float** is the amount of time an activity can be delayed without delaying a succeeding activity or the project finish date.

Calculating the Critical Path

- Develop a good network diagram.
- Add the duration estimates for all activities on each path through the network diagram.
- The longest path is the critical path.
- If one or more of the activities on the critical path takes longer than planned, the whole project schedule will slip *unless* the project manager takes corrective action.

Determining the Critical Path for Project X

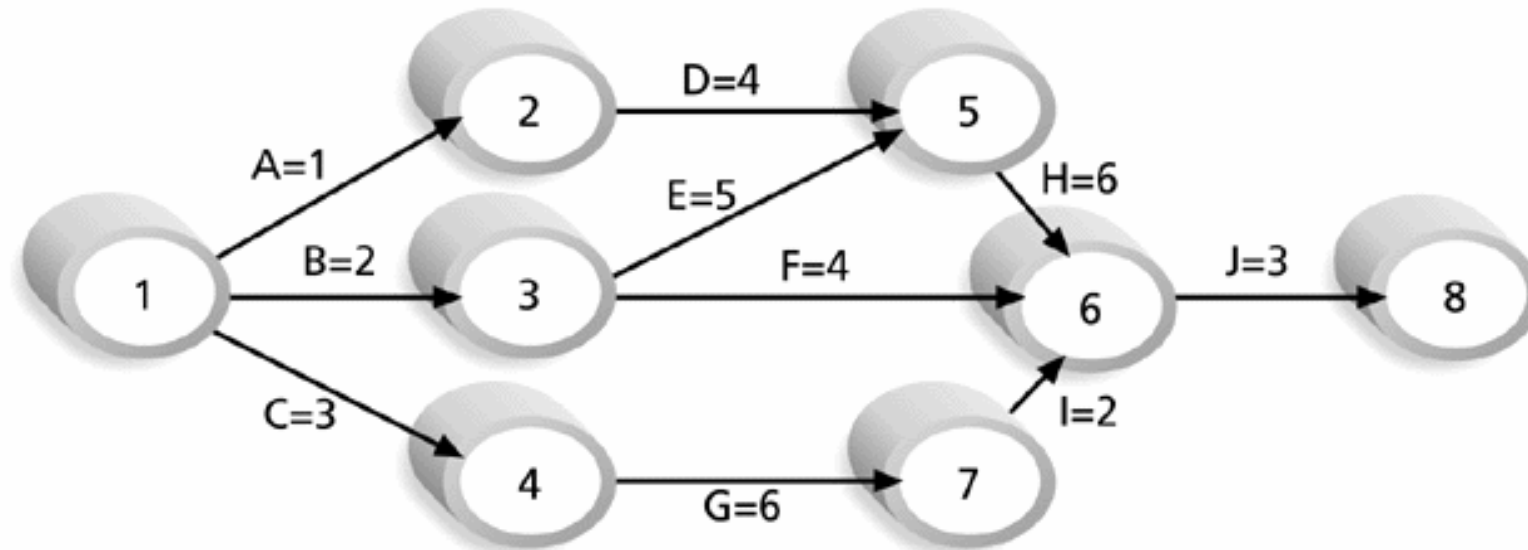

Note: Assume all durations are in days.

Path 1: A-D-H-J Length = $1+4+6+3 = 14$ days

Path 2: B-E-H-J Length = $2+5+6+3 = 16$ days

Path 3: B-F-J Length = $2+4+3 = 9$ days

Path 4: C-G-I-J Length = $3+6+2+3 = 14$ days

Since the critical path is the longest path through the network diagram, Path 2, B-E-H-J, is the critical path for Project X.

Using Critical Path Analysis to Make Schedule Trade-offs

- **Free slack** or **free float** is the amount of time an activity can be delayed without delaying the early start of any immediately following activities.
- **Total slack** or **total float** is the amount of time an activity can be delayed from its early start without delaying the planned project finish date.
- A **forward pass** through the network diagram determines the early start and finish dates.
- A **backward pass** determines the late start and finish dates.

Calculating Early and Late Start and Finish Dates

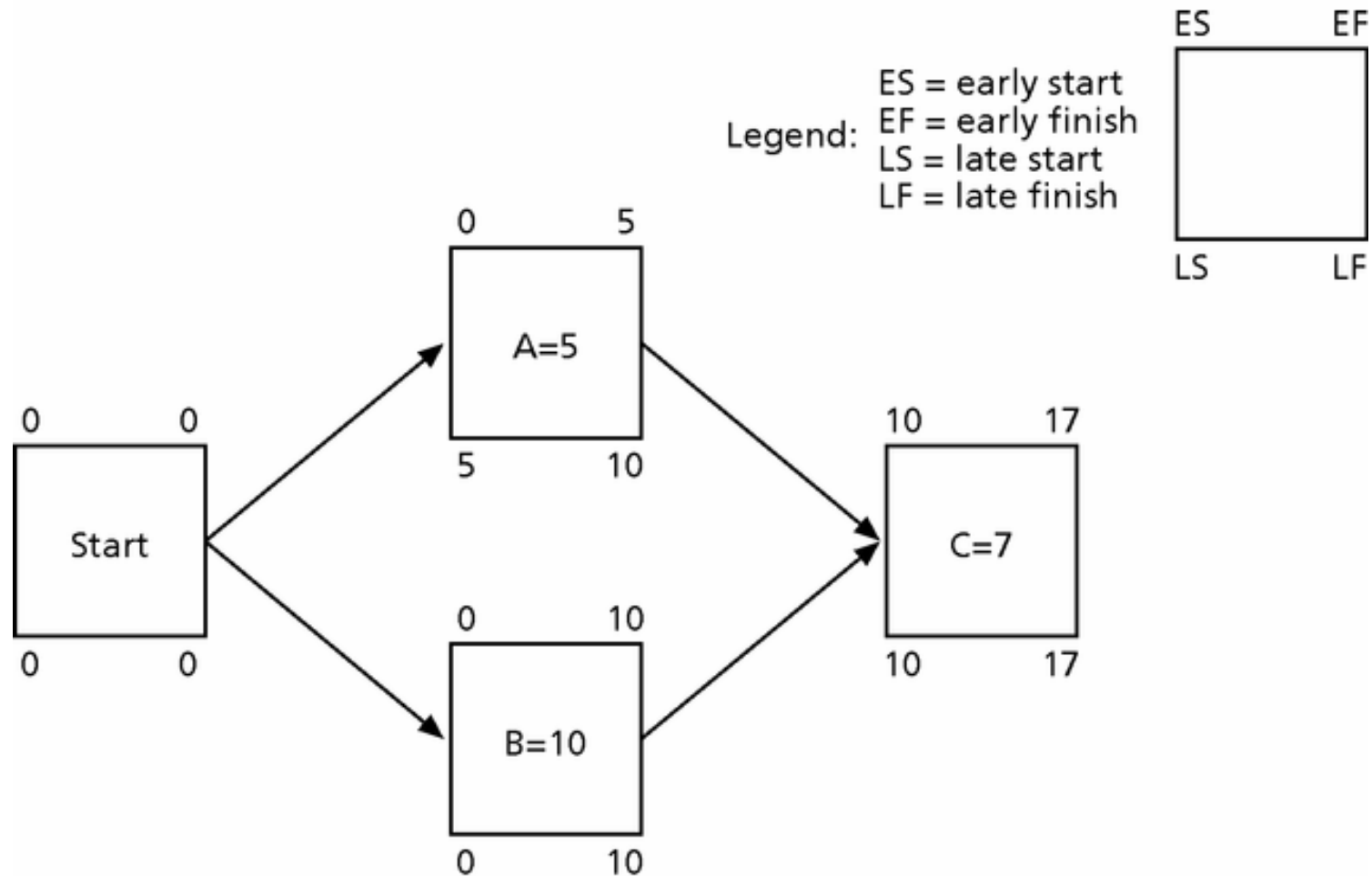

Free and Total Float or Slack for Project X

TASK NAME	START	FINISH	LATE START	LATE FINISH	FREE SLACK	TOTAL SLACK
A	6/1/05	6/1/05	6/3/05	6/3/05	0d	2d
B	6/1/05	6/2/05	6/1/05	6/2/05	0d	0d
C	6/1/05	6/3/05	6/3/05	6/7/05	0d	2d
D	6/2/05	6/7/05	6/6/05	6/9/05	2d	2d
E	6/3/05	6/9/05	6/3/05	6/9/05	0d	0d
F	6/3/05	6/8/05	6/14/05	6/17/05	7d	7d
G	6/6/05	6/13/05	6/8/05	6/15/05	0d	2d
H	6/10/05	6/17/05	6/10/05	6/17/05	0d	0d
I	6/14/05	6/15/05	6/16/05	6/17/05	2d	2d
J	6/20/05	6/22/05	6/20/05	6/22/05	0d	0d

Using the Critical Path to Shorten a Project Schedule

- Three main techniques for shortening schedules:
 - **Shortening** the duration of critical activities or tasks by adding more resources or changing their scope.
 - **Crashing** activities by obtaining the greatest amount of schedule compression for the least incremental cost.
 - **Fast tracking** activities by doing them in parallel or overlapping them.

Importance of Updating Critical Path Data

- It is important to update project schedule information to meet time goals for a project.
- The critical path may change as you enter actual start and finish dates.
- If you know the project completion date will slip, negotiate with the project sponsor.

Critical Chain Scheduling

- **Critical chain scheduling** is a method of scheduling that considers limited resources when creating a project schedule and includes buffers to protect the project completion date.
- Uses the **Theory of Constraints (TOC)**, a management philosophy developed by Eliyahu M. Goldratt and introduced in his book *The Goal*.
- Attempts to minimize **multitasking**, which occurs when a resource works on more than one task at a time.

Multitasking Example

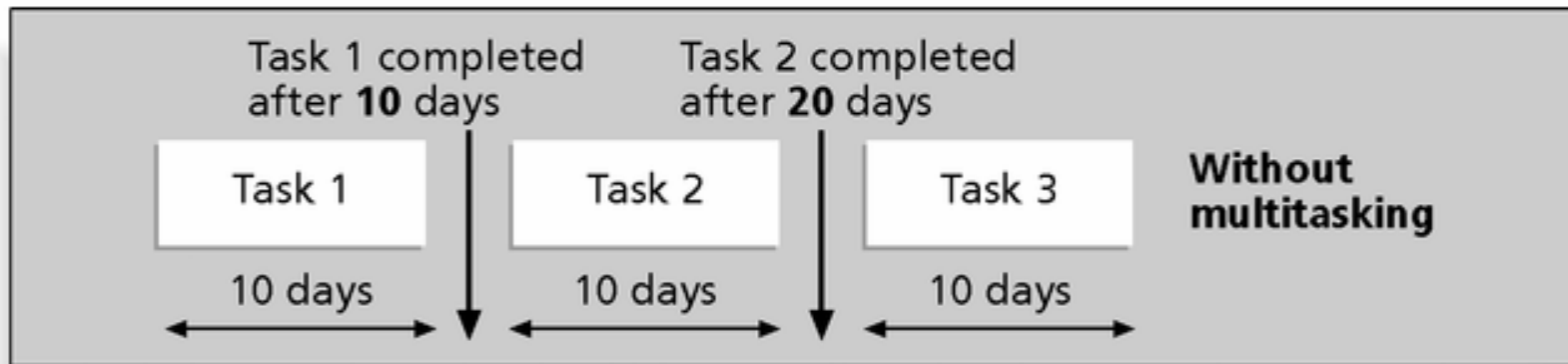

Figure 6-10a. Three Tasks Without Multitasking

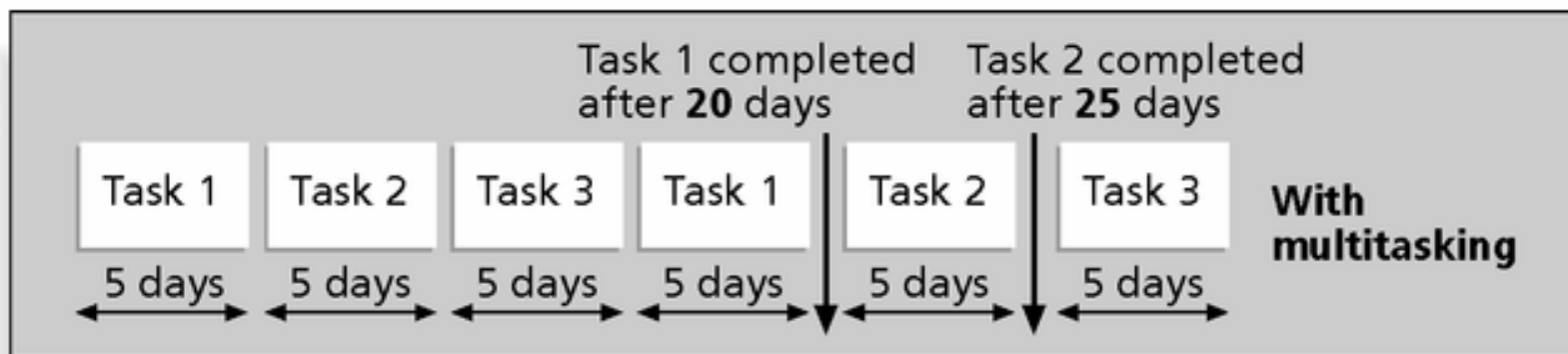
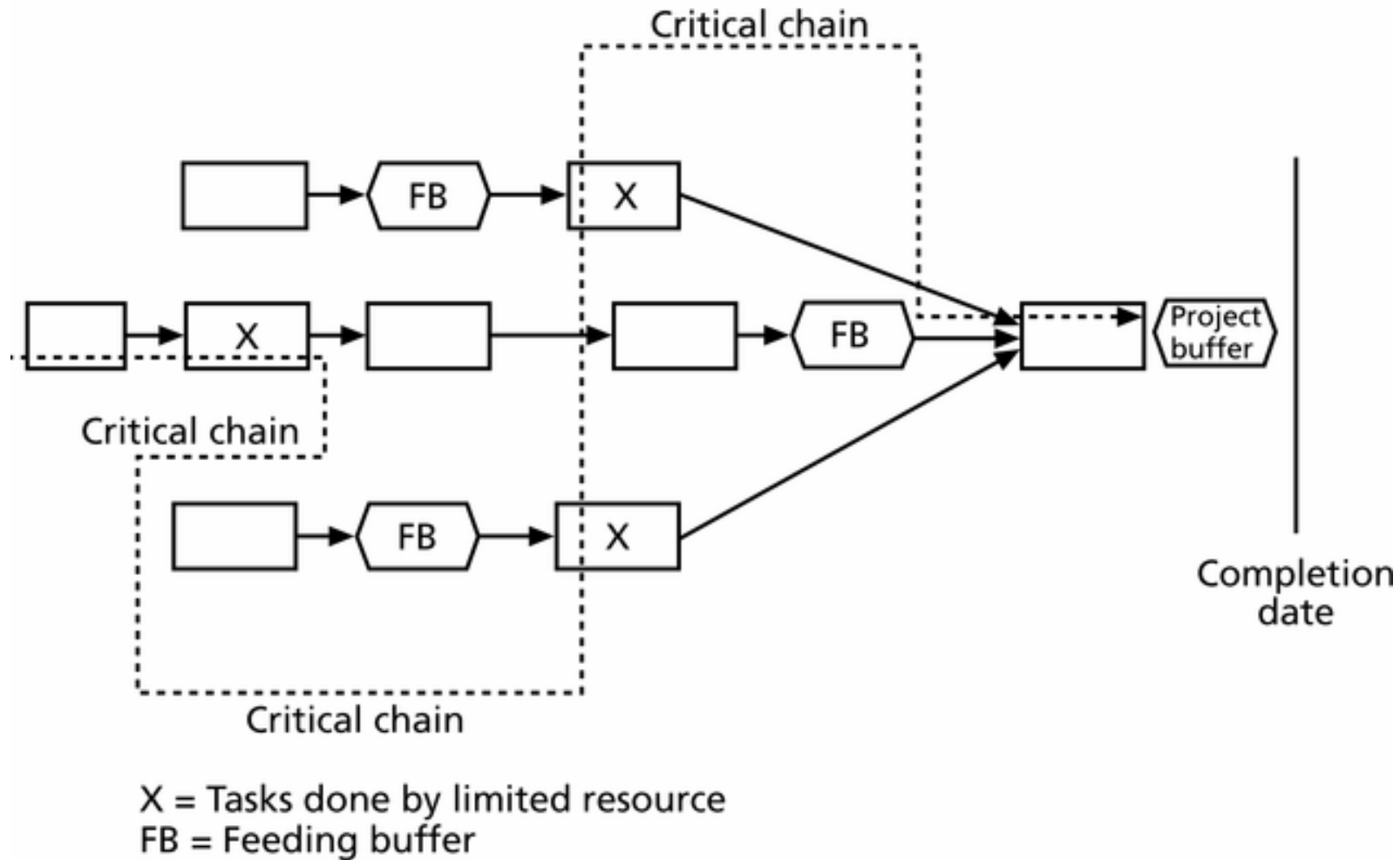

Figure 6-10b. Three Tasks With Multitasking

Buffers and Critical Chain

- A **buffer** is additional time to complete a task.
- **Murphy's Law** states that if something can go wrong, it will.
- **Parkinson's Law** states that work expands to fill the time allowed.
- In traditional estimates, people often add a buffer to each task and use the additional time whether it's needed or not.
- Critical chain scheduling removes buffers from individual tasks and instead creates:
 - A **project buffer** or additional time added before the project's due date.
 - **Feeding buffers** or additional time added before tasks on the critical path.

Example of Critical Chain Scheduling



Program Evaluation and Review Technique (PERT)

- PERT is a network analysis technique used to estimate project duration when there is a high degree of uncertainty about the individual activity duration estimates.
- PERT uses **probabilistic time estimates**:
 - Duration estimates based on using optimistic, most likely, and pessimistic estimates of activity durations, or a three-point estimate.

PERT Formula and Example

- PERT weighted average =

$$\frac{\text{optimistic time} + 4X \text{ most likely time} + \text{pessimistic time}}{6}$$

- Example:

PERT weighted average =

$$\frac{8 \text{ workdays} + 4 X 10 \text{ workdays} + 24 \text{ workdays}}{6} = \mathbf{12 \text{ days}}$$

where:

optimistic time= 8 days

most likely time = **10 days**

pessimistic time = 24 days

Therefore, you'd use **12 days** on the network diagram instead of 10 when using PERT for the above example.

Schedule Control

- Perform reality checks on schedules.
- Allow for contingencies.
- Don't plan for everyone to work at 100 percent capacity all the time.
- Hold progress meetings with stakeholders and be clear and honest in communicating schedule issues.

Schedule Control

- Goals are to know the status of the schedule, influence factors that cause schedule changes, determine that the schedule has changed, and manage changes when they occur.
- Tools and techniques include:
 - Progress reports.
 - A schedule change control system.
 - Project management software, including schedule comparison charts, such as the tracking Gantt chart.
 - Variance analysis, such as analyzing float or slack.

Reality Checks on Scheduling

- Review the draft schedule or estimated completion date in the project charter.
- Prepare a more detailed schedule with the project team.
- Make sure the schedule is realistic and followed.
- Alert top management well in advance if there are schedule problems.

Working with People Issues

- Strong leadership helps projects succeed more than good PERT charts do.
- Project managers should use:
 - Empowerment
 - Incentives
 - Discipline
 - Negotiation

Using Software to Assist in Time Management

- Software for facilitating communication helps people exchange schedule-related information.
- Decision support models help analyze trade-offs that can be made.
- Project management software can help in various time management areas.

Project 2003 Features Related to Project Time Management

REPORTS	VIEWS AND TABLE VIEWS	FILTERS
Overview reports: critical tasks and milestones	Gantt chart, network diagram, Tracking Gantt chart, schedule, tracking, variance, constraint dates, and delay	All tasks, completed critical tasks, incomplete tasks, and milestone tasks
Current activities reports: unstarted tasks, tasks starting soon, tasks in progress, completed tasks, should have started tasks, and slipping tasks		
Assignment reports: who does what and when		

Words of Caution on Using Project Management Software

- Many people misuse project management software because they don't understand important concepts and have not had training.
- You must enter dependencies to have dates adjust automatically and to determine the critical path.
- You must enter actual schedule information to compare planned and actual progress.

Chapter Summary

- Project time management is often cited as the main source of conflict on projects, and most IT projects exceed time estimates.
- Main processes include:
 - Activity definition
 - Activity sequencing
 - Activity resource estimating
 - Activity duration estimating
 - Schedule development
 - Schedule control